

CE
2460

Optiflex
TRIO
IOLs RANGE

**DESIGNED
TO MEET
YOUTHFUL
VISION**



biotech

VISION CARE

Optifex Trio is diffractive refractive trifocal intraocular lens used for presbyopia correction

It's unique diffraction pattern gives balanced light distribution at all distances and results in spectacle independence for vision

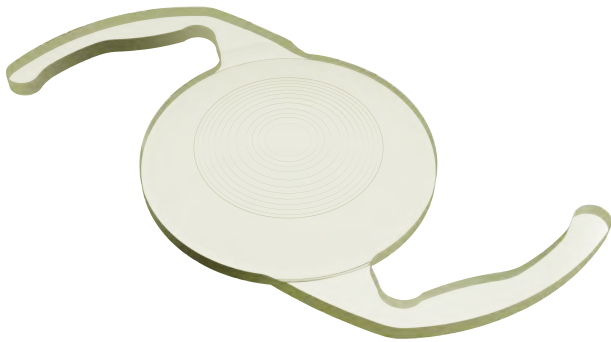

WITH **BLISS** BRILLIANT LIGHT SENSING SYSTEM

- Designed for Natural Adaptation
- Effective utilization of unused light energy
- Optimum asymmetric and balanced light distribution at each focal point
- Specially optimized diffractive zone for intermediate and near vision without affecting distance vision
- Pupil independent

Unique Refractive Diffractive Aspheric Design

- Optimized center zone (Refractive Zone) supports angle Alpha + Kappa: minimizes haloes and glares
- Optimized 4mm diffractive zone reduces dependence on pupil size
- Peripheral refractive zone supports the distance vision in low light condition (Scotopic condition)

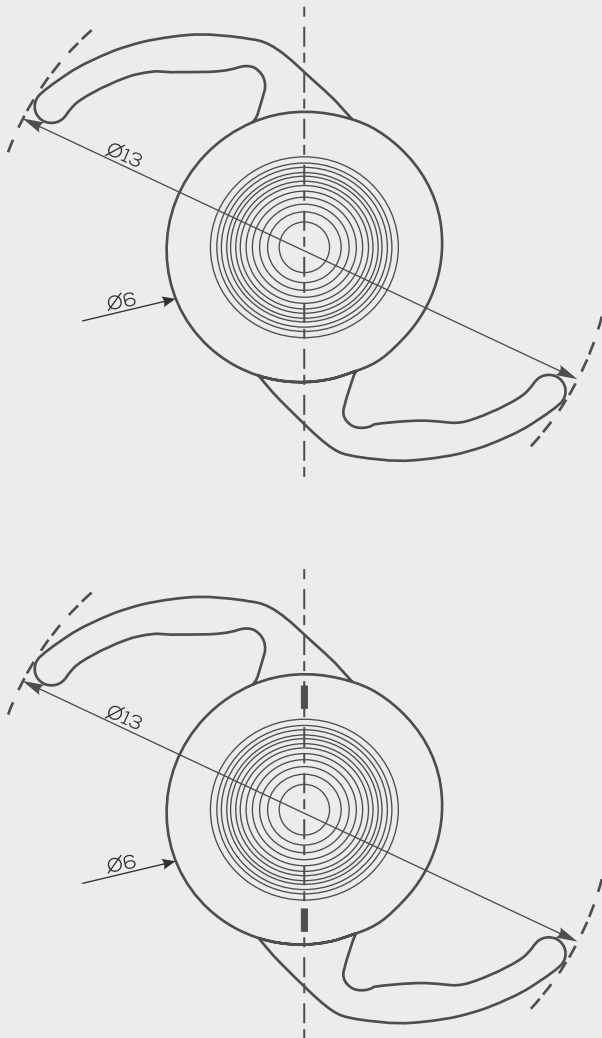

Top and side view
of the Optiflex Trio²

Aspheric / Aspheric Toric
Anterior Diffractive Surface

OPTIFLEX TRIO FEATURES

- Good visual outcomes at all distances
- 97% patient satisfaction
- Reduces spectacle dependency
- Complete visual restoration with good visual quality outcomes
- Glistening free
- Minimal dysphotopsia
- Optimized near add power of +3.5 D works for ideal reading distance at about 38 cm and intermediate add power of +1.85 D works for vision at about 72 cm
- Optimum Asymmetric and balanced light distribution of 45% for far, 27% for intermediate and 28% for near- distances, provides excellent vision at all distances
- High spectacle independence resulting into patient satisfaction
- Good visual quality interms of Distance, intermediate & near vision
- Very high light transmittance gives good quality of vision in all lighting conditions
- Wide range of cylindrical correction

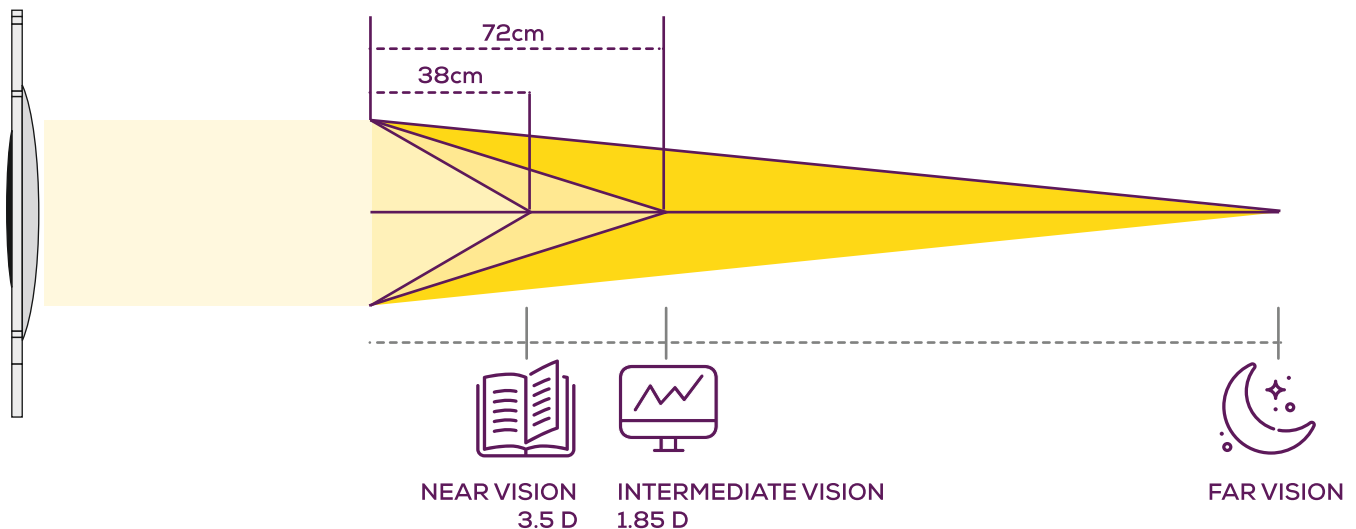

GENERAL FEATURES

- Lens material with natural yellow chromophore prevents risk of Age Related Macular Degeneration (ARMD) and doesn't disturb the circadian rhythm. Moreover, it doesn't attribute to altered color perception, hence enhances the contrast sensitivity
- Negative spherical aberration compensates cornea's positive spherical aberration
- Abbe no. 49 – reduces Chromatic Aberration
- Good visual outcomes at all distances
- 360° square edge
- IOL remains Glistenings-free



DEFOCUS CURVE

The defocus curve of the Optiflex TRIO shows un-interrupted post-operative visual outcomes for distant, intermediate and near objects.

Optiflex TRIO provides extended range of 35-90 cm between intermediate & near vision, for daily activities.

Positive portion of the defocus curve proves the tolerance for refraction errors for distance vision, occurred during pre-operative measurements due to either human or instrumental errors.

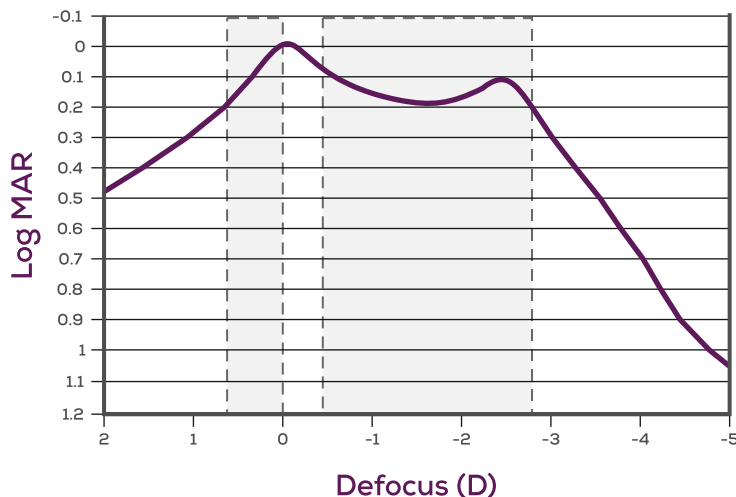

Defocus curves showing avg. visual acuity of patients implanted with OPTIFLEX TRIO

POST OPERATIVE REFRACTIVE OUTCOMES ¹ (N=54)

63% patients were with in range of +/- 0.13D & 93% patients were with in range of +0.13D to -0.50D.

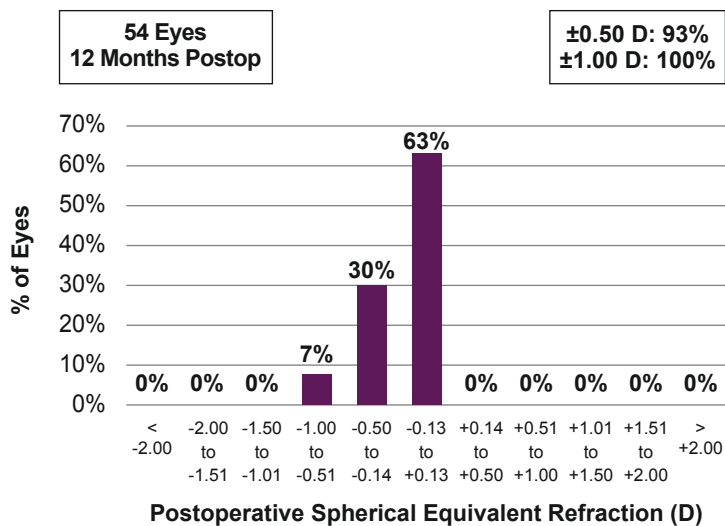

VISUAL OUTCOMES ¹

UDVA : At 12 months, the mean binocular UDVA and CDVA were 0.00 and -0.06 LogMAR respectively. Uni-ocularly, 59% eyes had UDVA of 20/20 or better, while all eyes had a minimum UDVA of 20/32. Binocularly, 78% patients had UDVA of 20/20 or better, while all patients, had a minimum UDVA of 20/25

52% of eyes had post-op UDVA same as post-op CDVA, whereas 35% of eyes had post-op UDVA better than post-op CDVA by 1 line and 13% eyes had post-op UDVA better than post-op CDVA by 2 lines

Intermediate Visual Outcomes

At 12 months, the mean uncorrected visual acuity at 60 cm was 0.07 LogMAR and at 80 cm was 0.03 LogMAR.

Near Visual Outcomes

Ninety-seven percent (n = 26) of patients had binocular uncorrected near vision of N6 or better, while all patients had a minimum UNVA of N8

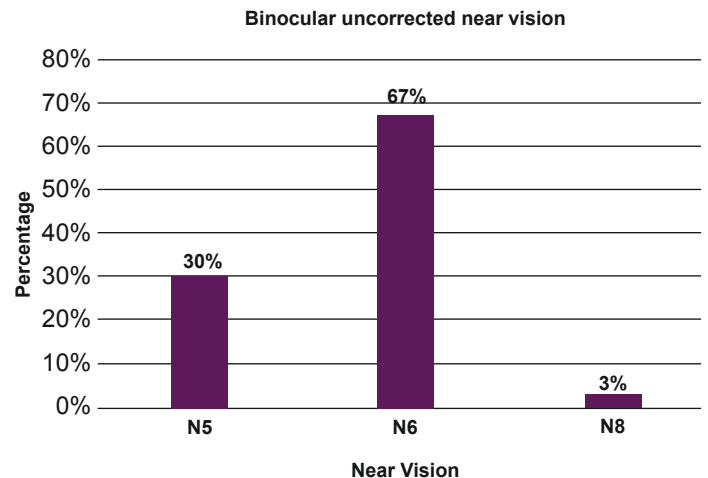
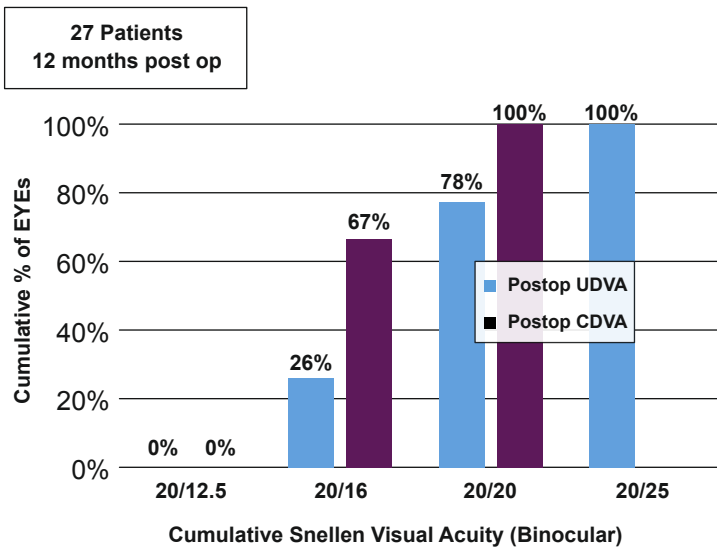

ROTATIONAL STABILITY ³ (N=50)

Excellent rotational stability due to advanced hydrophobic material and larger overall length of the lens. Rotational stability for 88% cases, has been observed within 0°- 5°.

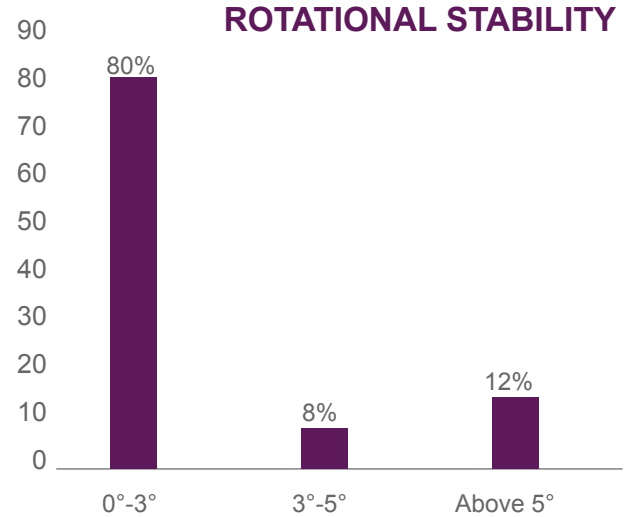

RESIDUAL CYLINDER ³ (N=74)

Clinical results of Optiflex TRIO show very good post-operative results. In 64% cases, residual cylinder measured is within +/- 0.25D & in 81% cases, residual cylinder measured is within +/- 0.50D. These post-operative cylindrical results prove excellent rotational stability for Optiflex TRIO.

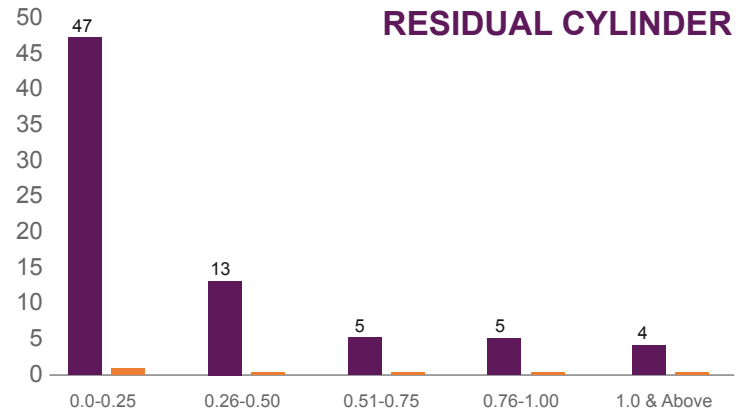

GLARES AND HALOS ³

The mean score of dysphotopsia symptoms (graded from 0-10, 0 being minimal and 10 being severe) reduced significantly at 12 months (0.61 ± 0.49) when compared to 3 months. No patient had complained of severe dysphotopsia.



SPECTACLE INDEPENDENCE ¹

Spectacle independence scores (graded from 0–10, 0 being dependent on glasses and 10 being completely glass free) for distance, intermediate and near vision were 9.56, 9.55 and 9.25 respectively at 12 months. Spectacle independence was found to be high, resulting in good patient satisfaction.

READING SPEED ¹

The binocular uncorrected reading speeds (words per minute) at 40, 60 and 80 cm showed improvement from 1 week to 12 months.

Reading speeds (wpm)

		1 Week	1 Month	3 Months	6 Months	1 Year	p-Value*
40cm	Uncorrected	162±40	163±40	164±40	164±40	165±40	0.99
	Corrected	163±40	165±40	166±40	166±40	167±40	0.99
	p-value**	0.86	0.85	0.85	0.85	0.86	
60cm	Uncorrected	167±31	168±33	169±33	169±33	170±33	0.98
	Corrected	169±31	170±33	171±33	171±33	172±33	0.98
	p-value**	0.76	0.76	0.77	0.77	0.76	
80cm	Uncorrected	170±31	171±33	172±34	172±34	173±34	0.99
	Corrected	172±31	173±34	174±34	174±34	175±34	0.98
	p-value**	0.78	0.78	0.82	0.82	0.85	

LIGHT ENERGY DISTRIBUTION

(%) at various Pupil Size ²

The refractive energy distribution of Optiflex Trio in different lighting conditions like photopic and scotopic, is shown in the graph. It shows the light distribution in far, intermediate and near distances at various pupil sizes

Energy Distribution at three focal points at various aperture size at 546 nm

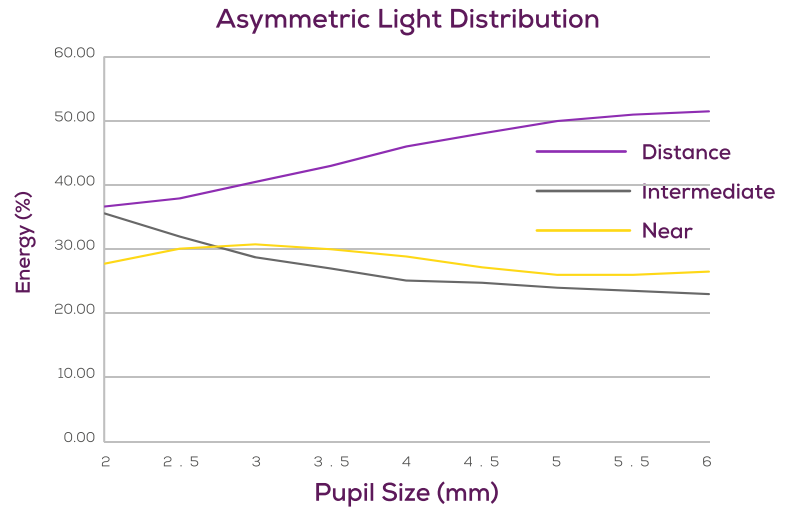

OPTIMIZED LIGHT DISTRIBUTION

Light Yield ²

- 88.3% transmitted light energy provides good quality of vision and improves contrast sensitivity
- Optimized diffractive zone ensures minimized pupil dependency in any lighting conditions
- Optiflex trio with its unique step design, exhibits minimum loss of light and yields 88.3% of light for sharp and clear vision at various distances



MODULAR TRANSFER FUNCTION CURVE

- Optiflex TRIO provides good visual acuity at all distances
- Sufficient energy distribution at each focal point
- Clear separation of three peaks provides clear vision and excellent contrast at each focal point
- Extended depth of Intermediate provides extended range of quality vision for daily activities
- Covers 60-90 cm Intermediate distance without loss of contrast sensitivity

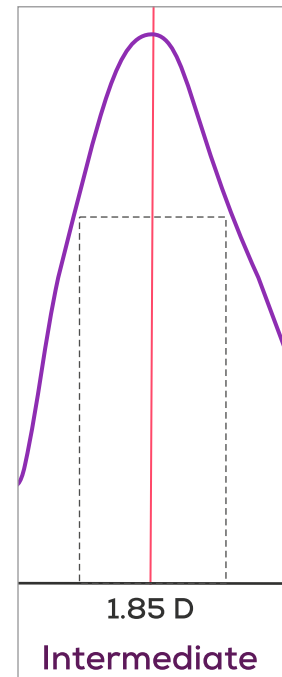
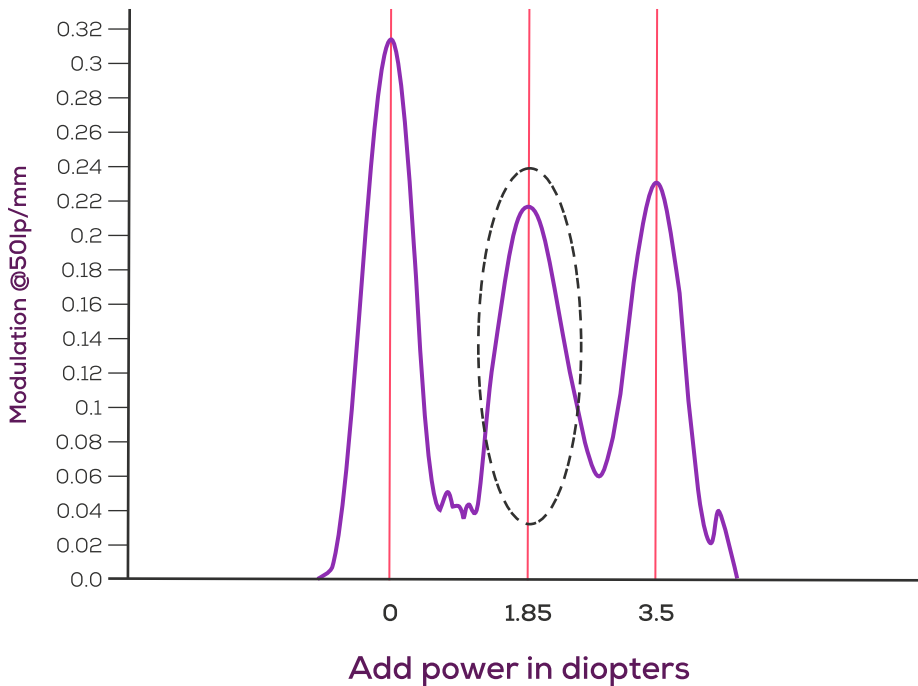

USAF RESOLUTION TARGET IMAGES

recorded for Biotech Optiflex TRIO ²

USAF images given here show the qualitative resolution performance of Optiflex TRIO at various pupil sizes.

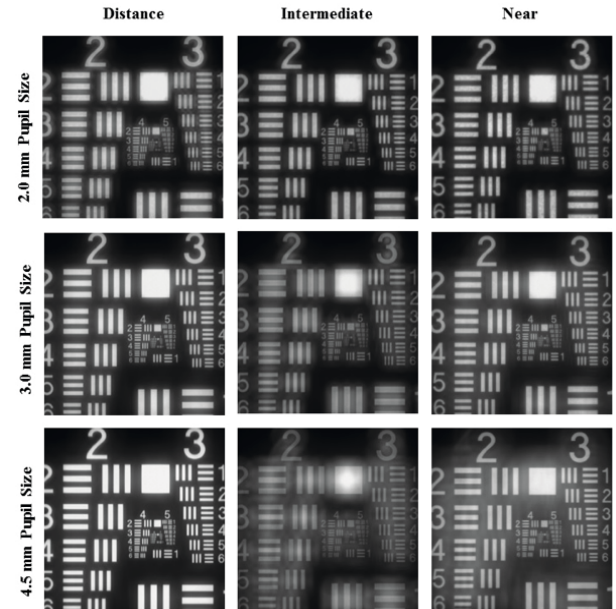

LIGHT TRANSMITTANCE CURVE

compared with natural human lens ²

Optiflex TRIO blocks the harmful UV light and filters Violet and Blue light without losing the contrast sensitivity. The transmittance property of Optiflex TRIO is similar to the transmittance of a young human crystalline lens. This graph clearly shows the blockage of harmful UV light and filtration of the Violet-Blue light without losing contrast sensitivity.

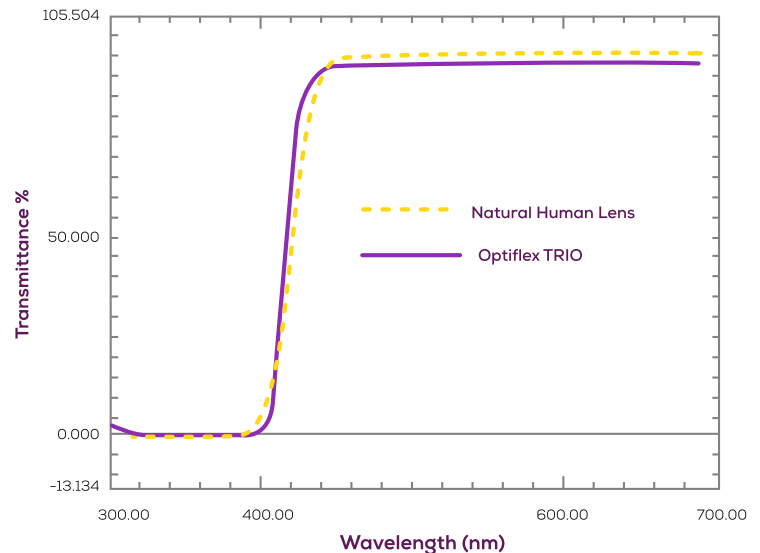

Light Transmittance Graph of Optiflex TRIO compared with natural young human lens

NOTE : Human lens data are from Boettner and Wolter (1962)¹.

SPECIFICATIONS

MATERIAL	Hydrophobic Acrylic containing Natural Yellow Chromophore		
OPTIC TYPE	Single Piece, Diffractive -Refractive, 360° Square Edge with Toric Aspheric Optic		
NEAR ADDITION	+3.5 D		
INTERMEDIATE ADDITION	+1.85 D		
OPTIC SIZE	6.00 mm		
OVERALL SIZE	13.00 mm		
ANGULATION	0°		
ACD	5.28		
REFRACTIVE INDEX	1.48		
RECOMMENDED ULTRASOUND A-CONSTANT	SRK-T 118.60		
RECOMMENDED OPTICAL A-CONSTANTS	HAIGIS α_0 :1.309, α_1 :0.400, α_2 :0.100		HOFFER Q ACD: 5.52
	Holl 1 : 1.74	Holl 2 : 1.79	SRK - T 119.00
	SRK - II 119.40		Barrett 1.88
DIOPTRER RANGE	+7.0 D to +30.0 D (with 0.5 D steps)		
CYLINDER RANGE (for TORIC VERSION)	0.0 D to 6.0 D (with 1.0D step between 0.0D to 1.0D, with 0.5D step between 1.0D to 1.5D & with 0.75D step between 1.5D to 6.0D)		
IMPLANTATION SITE	Capsular Bag		
STERILIZATION	Irradiation		
SHELF LIFE	4 years from date of manufacture		

MODELS AVAILABLE

Model	Near Addition	Intermediate Addition	Cylinder power		Recommended Range of Corneal astigmatic correction
			At IOL Plane	At Corneal Plane ⁴	
CYL-0.00 D	+3.5D	1.85 D	0.00 D	0.00 D	0.00 D to 0.24 D
CYL-1.00 D	+3.5D	1.85 D	1.00 D	0.68 D	0.25 D to 0.86 D
CYL-1.50 D	+3.5D	1.85 D	1.50 D	1.03 D	0.87 D to 1.25 D
CYL-2.25 D	+3.5D	1.85 D	2.25 D	1.54 D	1.26 D to 1.75 D
CYL-3.00 D	+3.5D	1.85 D	3.00 D	2.05 D	1.76 D to 2.25 D
CYL-3.75 D	+3.5D	1.85 D	3.75 D	2.57 D	2.26 D to 2.75 D
CYL-4.50 D	+3.5D	1.85 D	4.50 D	3.08 D	2.76 D to 3.25 D
CYL-5.25 D	+3.5D	1.85 D	5.25 D	3.60 D	3.26 D to 3.75 D
CYL-6.00 D	+3.5D	1.85 D	6.00 D	4.11 D	3.76 D and above

To choose suitable model, please logon to

 www.biotechcalculators.com

REFERENCES

1. Clinical Ophthalmology 2021;15 3247-3257
2. Data on file with Biotech Vision Care Pvt. Ltd.
3. Data of product evaluation with Biotech Vision Care Pvt. Ltd.
4. <https://jamanetwork.com/> on 07/05/2022





Scan For Biotech Connect App

MANUFACTURING FACILITY

BIOTECH EUROPE MEDITECH INC. LIMITED | Unit AF 2, IDA Business & Technology Park,
Gallowstown, Co Roscommon, F42 P862, IRELAND. | Email: intlsales@biotechhealthcare.com | www.biotechhealthcare.com